

- Corner fixed and flex poles, Ø 30/40/50 mm, white, yellow, yellow fluorescent
 - Pali calcio angolo fissi e snodati, Ø 30/40/50 mm, bianco, giallo, giallo fluorescente

- Corner flex pole accident prevention
 - Palo calcio angolo snodato antinfortunistico

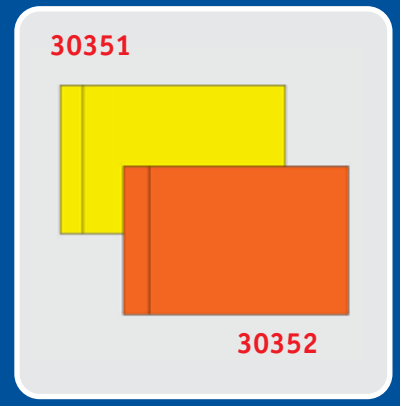

- Corner flag different size Ø 30/40/50 mm
 - Bandiere calcio angolo diverse misure Ø 30/40/50 mm



- Flag clip Ø 25/30 mm
 - Clip bloccabandiera Ø 25/30 mm

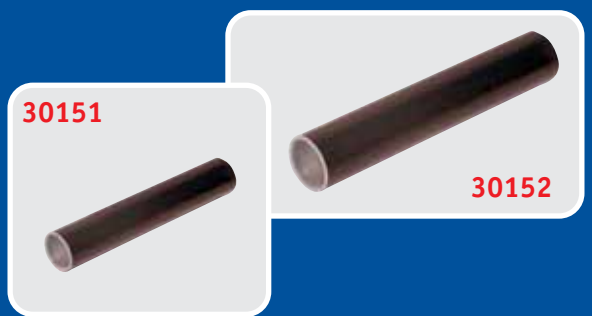

- Tin for corner pole Ø 30/50 mm
 - Bussola per palo calcio angolo Ø 30/50 mm



32900 32901

- Corner flexible pole "GUMMY" - Ø 30 mm, h. 55 cm
- Palo calcio angolo flessibile "GUMMY" - Ø 30 mm, h. 55 cm

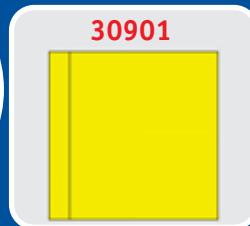

30901



30201

- Corner flag for GUMMY, with clip Ø 30 mm
- Bandiera calcio angolo GUMMY con bloccabandiera Ø 30 mm

32900 - Red or blue colour - colore rosso o blu

32901 - Yellow or orange fluorescent - colore giallo o arancio fluorescente



30301 30251 30252

- Linesman poles fixed - rotating
- Aste guardalinee fisse - ruotanti



30854 30853 30852 30851 30801

- Linesman flags
- Bandierine per aste guardalinee

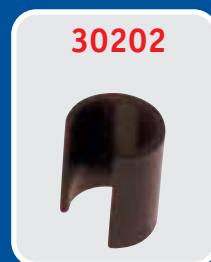

30202

- Flag clip Ø 20 mm
- Clip bloccabandiera Ø 20 mm



30311

- Linesman set "professional"
- Set aste guardalinee "professional"

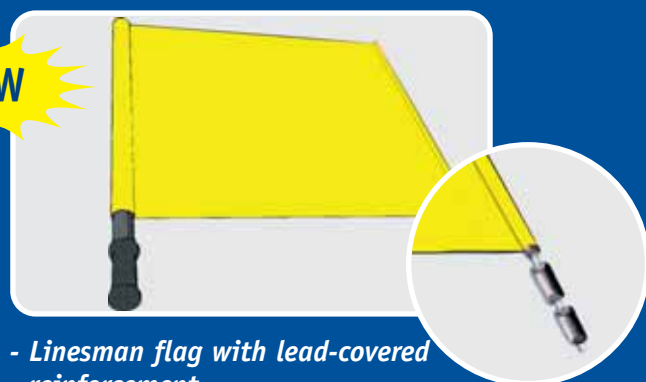

- Linesman flag with lead-covered reinforcement
- Bandierina con rinforzo piombato





31041 - Change player single board "HANDY", manual, double face, from 1 to 99 yellow/orange fluorescent
- Tabella cambio giocatori singola "HANDY", manuale, bifacciale, da 1 a 99 giallo/arancio fluorescente

OUT**IN**

31042

NEW



31042 - Change player double board "HANDY TWIN", manual, double face, from 1 to 99 yellow/orange fluorescent
- Tabella cambio giocatori doppia "HANDY TWIN", manuale, bifacciale, da 1 a 99 giallo/arancio fluorescente

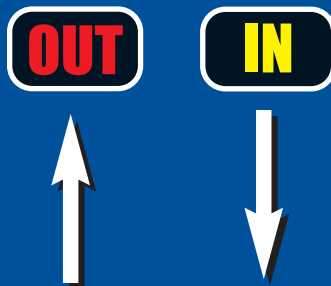



- Change player number book, plasticized, double numeration
- Blocchi numeri sostituzione giocatori, plastificati, doppia numerazione

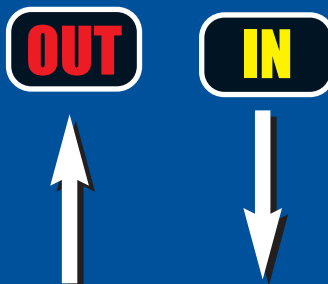



31061 - Score-board table 0-30 double face with "Time-out" pocket - personalization by request
- Segnapunti da tavolo 0-30 bifacciale con tasca "Time-out" - personalizzabile su richiesta



31062 - Score-board table 0-50 double face with "Time-out" pocket - personalization by request
- Segnapunti da tavolo 0-50 bifacciale con tasca "Time-out" - personalizzabile su richiesta



31065 - Score-board table 0-199 with "Time-out" pocket - personalization by request
- Segnapunti da tavolo 0-199 con tasca "Time-out" - personalizzabile su richiesta





32001 - *Flex barrier*
- Barriera snodata



32051 - *Trolley for flex barrier*
- Carrello per barriera
snodata



32301 - *Fixed barrier, adjustable height*
- *Barriera fissa regolabile in altezza*



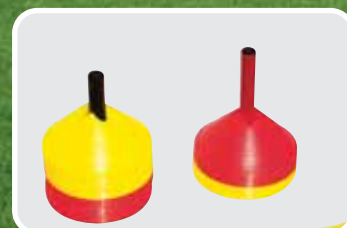

32601 / 32651 - Space delimiting with 4 notches for poles, packaging 24 and 48 pcs.
 - Delimitatori spazi con 4 sedi per aste, confezioni da 24 e 48 pz.



32662 - Cone yellow/orange fluorescent h. 40 cm
 - Cono giallo/arancio fluorescente h. 40 cm



NEW

- 32660** - Cone yellow/orange fluo h. 30 cm - without holes with notches for hoop
- Cono giallo/arancio fluo h. 30 cm senza fori con sedi per cerchio



- 32661** - Cone yellow/orange fluo h. 30 cm - with 12 holes for cross-bar and notches for hoop
- Cono giallo/arancio fluo h. 30 cm con 12 fori per inserimento asta e sedi per cerchio



NEW

- 32685** - Set FOOTBALL-TENNIS "outdoor" with International Rules size
- Set CALCIO-TENNIS "outdoor" con dimensioni secondo le Normative Internazionali



- 32686** - Set FOOTBALL-TENNIS "indoor" with International Rules size
- Set CALCIO-TENNIS "indoor" con dimensioni secondo le Normative Internazionali



NEW

- 32680** - Training speed ladder - lenght 4 m
- Scaletta per allenamento in velocità - lunghezza 4 m





32750 - Minigoal "GYM" patented, m 1,60 x h. 1,10 with nets
- Miniporta "GYM" brevettata, m 1,60 x h. 1,10 con reti



32751 - Couple minigoal "Flex" flexible, m 1,50 x h. 1,10 with nets
- Coppia miniporta "Flex" snodata, m 1,50 x h. 1,10 con reti



32701 - Adjustable arch, cm 30 - 80 for precision shot
- Arco regolabile, cm 30 - 80 per tiro di precisione



- Slalom poles Ø 25/30 mm with different colours and ferrules
- Pali slalom Ø 25/30 mm con diversi colori e puntali



- Flexible slalom pole "GUMMY" - Ø 30 mm, h. 55 cm - steel ferrule
- Palo slalom flessibile "GUMMY" - Ø 30 mm, h. 55 cm - puntale acciaio

32900 - Red or blue colour - colore rosso o blu

32901 - Yellow or orange fluorescent - colore giallo o arancio fluorescente

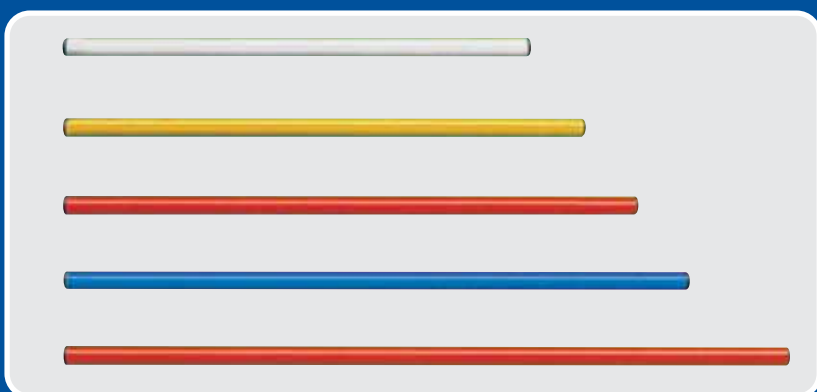

- Gymnastic pole Ø 25 mm, different colours
- Asta ginnica Ø 25 mm, differenti colori

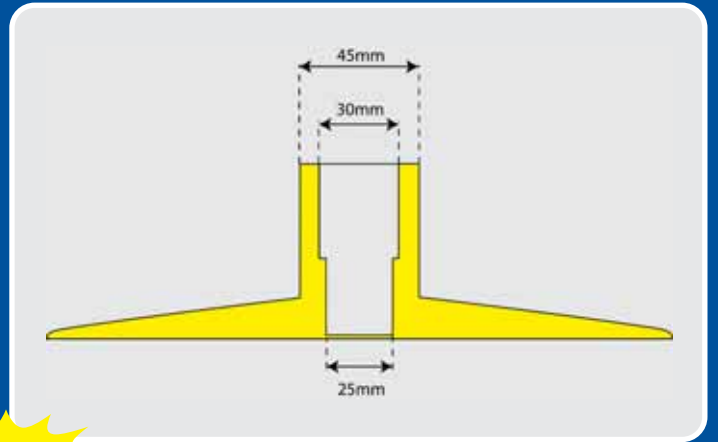

NEW



33405 - Hurdle base with holes \varnothing 25 and 30 mm - yellow
- Base per ostacolo con fori \varnothing 25 e 30 mm - gialla



- Slalom Poles \varnothing 25 mm with base
- Pali slalom \varnothing 25 mm con base



- Base hole \varnothing 25 mm
- Base foro \varnothing 25 mm



33525 - Hurdle set Ø 25 x 1600 mm yellow/red/blue with steel ferrule
- Set ostacolo Ø 25 x 1600 mm giallo/rosso/blu con puntale acciaio

33522 - Hurdle set Ø 25 x 1600 mm, yellow/red/blue with 2 bases
- Set ostacolo Ø 25 x 1600 mm, giallo/rosso/blu con 2 basi



- Ferrules
- Puntali



33501
- Hurdle clip Ø 30 mm
- Clip supporto ostacoli Ø 30 mm



33502
- Hurdle clip Ø 25 mm
- Clip supporto ostacoli Ø 25 mm



33401
- Base hole Ø 25 mm, yellow/red/blue
- Base foro Ø 25 mm, giallo/rosso/blu



33405
- Base with hole Ø 25 and 30 mm, yellow
- Base con foro Ø 25 e 30 mm, gialla



33531 - Hurdle set "JUMP" with 7 positions h. 10-40 cm
 - Set ostacolo "JUMP" con 7 posizioni h. 10-40 cm



32662 - Cone yellow/orange fluorescent h. 40 cm
 - Cono giallo/arancio fluorescente h. 40 cm

33532 - Spare support for hurdle JUMP
 - Ritto per ostacolo JUMP



33541 - Hurdle set "JUMP 2" with 3 positions h. 10-25 cm
 - Set ostacolo "JUMP 2" con 3 posizioni h. 10-25 cm

NEW



32661 - Cone yellow/orange fluo h. 30 cm - with 12 holes for cross-bar and notches for hoop
 - Cono giallo/arancio fluo h. 30 cm con 12 fori per inserimento asta e sedi per cerchio

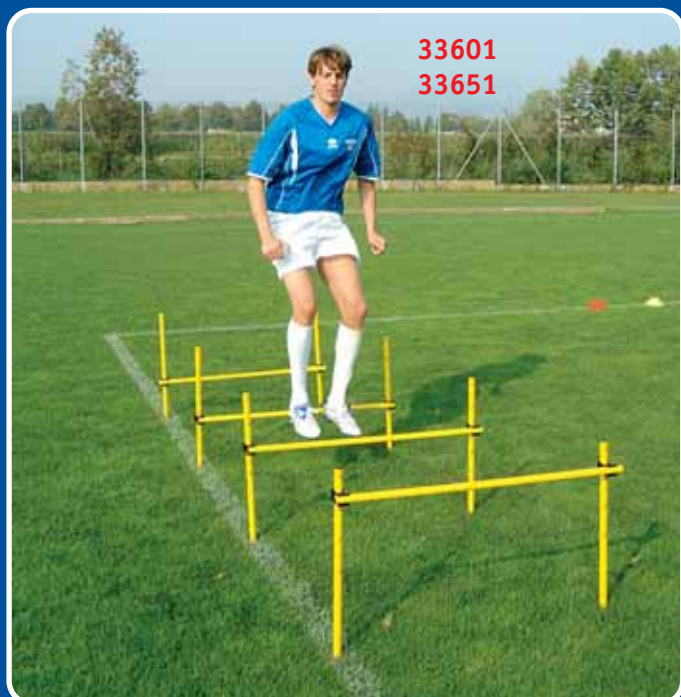

33601
33651

- Graduated hurdle set with steel ferrule size 30-60 cm or 50-100 cm
- Set ostacolo graduato con puntale in acciaio da 30-60 cm o 50-100 cm



33701
33751

- Graduated hurdle set with base size 30-60 cm or 50-100 cm
- Set ostacolo graduato con base da 30-60 cm o 50-100 cm



33502

- Hurdle clip Ø 25 mm
- Clip supporto ostacoli Ø 25 mm



33401

- Base hole Ø 25 mm, yellow/red/blue
- Base foro Ø 25 mm, giallo/rosso/blu



33405

- Base with hole Ø 25 and 30 mm, yellow
- Base con foro Ø 25 e 30 mm, gialla

NEW

**NEW
Patented**

**Born to save space
Nati per guadagnare spazio**

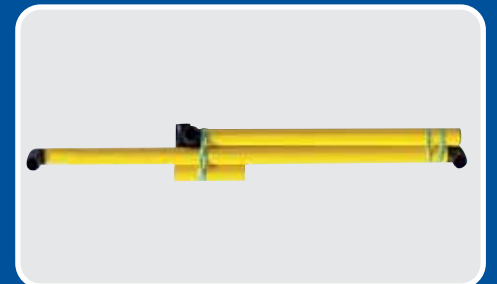
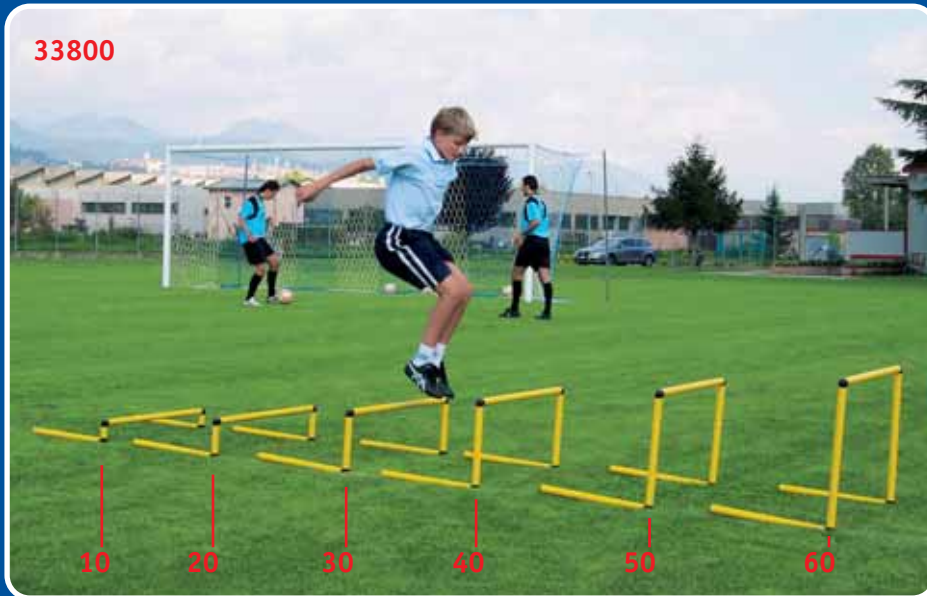

33800 - Hurdle set "MACH" different size 10-20-30-40-50-60 cm - patented
- Set ostacolo "MACH" differenti misure 10-20-30-40-50-60 cm - brevettato

*Example 33800/10
Esempio 33800/10*



33850 - Graduated hurdle set "MACH 2" size 10-60 cm - patented
- Set ostacolo graduato "MACH 2" da 10-60 cm - brevettato



33503 - Hurdle clip \varnothing 32 mm for hurdle "MACH 2"
- Clip supporto ostacolo "MACH 2" \varnothing 32 mm

Una forte passione per il calcio, ed una ventennale esperienza nel campo delle materie plastiche, hanno spinto, nel 1978, la LISKI ad intraprendere una propria linea di lavorazione che, inizialmente era rivolta alla produzione di pali da slalom ed accessori per piste da sci e si è poi ampliata con la produzione di attrezzature sportive.

Il progresso tecnico degli ultimi anni nel campo chimico ha reso disponibili nuovi materiali e tecnologie con cui la LISKI ha potuto soddisfare tutte le crescenti esigenze di atleti, allenatori e addetti ai lavori.

Oggi, a distanza di più di vent'anni la LISKI ha mantenuto la stessa passione nella cura dei propri prodotti, affiancandola ad un sistematico sviluppo tecnico assicurato da preziosi collaboratori che studiano e collaudano rigorosamente tutti gli articoli prima di essere immessi sul mercato.

Questa proficua alleanza tra tecnologia ed esperienza umana, ha permesso alla LISKI di essere costantemente presente nelle maggiori competizioni sportive e di fornire tutti i clubs, a partire dai maggiori fino ai più piccoli, di attrezzature intelligenti che risolvono i problemi degli allenatori rendendo meno faticoso il lavoro di preparazione tecnico/atletica dei giocatori.

Con questo bagaglio di esperienze la LISKI si propone a tutti coloro che lavorano nel settore sportivo, come interlocutore in grado di studiare e proporre nuove e pratiche soluzioni ad ogni problema.

Great passion for skiing, and twenty-year experience in the field of plastic materials, induced LISKI, in 1978, to do its own manufacturers, at the beginning for the production of flex poles and accessories for the preparation of ski slope and then with the production of sport equipment too.

In the last years the technical progress in chemical field has made available new materials and technologies by which LISKI could meet all the increasing requirements of athletes, trainers, and experts.

Now, after a period of more than twenty years, LISKI maintains the same attention in taking care of its own products, and helps itself with a systematic development, guaranteed by assistants who strictly study and test all the products before they are put on the market.

This profitable alliance between technology and human experiences, lets LISKI be always present during the most important international sport competitions, supplying all clubs, from the major till the smaller, of intelligent sport equipment which solve the trainer's problems, making less tiring the athletics preparation of players.

With this store of experience LISKI presents itself to all those who work in sports fields as someone who can study and suggest new and practical solutions for every problem.

